



PALM TREE SERIES

Foldable All In One Solar LED Street Light

User Manual

Thank you for choosing the PALM TREE SERIES Solar Street Light. For any questions, please email us.

Please refer to the actual products if the provided diagrams show slight differences.

Trouble Shooting

No	Situation	Trouble shooting steps	Solution
1	No light at night	Check if the solar panel is blocked from the sunlight by houses, trees and other obstacles	Clear obstructions or change installation location
		Check if there is any artificial light source(s) illuminate on the solar panel at the night	Remove the artificial light source(s) of interference or change the installation location
		Check the battery have power or not (There will be a green light flashing on microwave sensor if the battery have power)	Make sure cable connected, then put the solar lamp in strong sunshine charging 4~6 hours, then observe the lights at night.
		If all step above have no problem	Disconnect the cable between the solar panel and lamp, then connect it again, lamp will be lighting again
		Test battery voltage	If the battery is 0V, please replace by new battery. If the battery voltage is lower than 11 V, the battery has been protected automatically. Please use solar panel charge the battery directly (do not through solar charge controller), after full charged, battery voltage shows 14V or above 14V, then observe the lighting situation at night
	Test solar panel voltage	Test solar panel voltage at sunshine.if the volatge of solar panel lower than 10v, please replaced damaged solar panel	
2	A serious shortage of working time	Check if the solar panel is blocked from the sunlight by houses, trees and other obstacles	Clear obstructions or change installation location
		Check if the surface of the solar panel is dusty or covered	Clean the surface of solar panels as detailed above
		Confirm the working mode is correct or not	Use the remote control to readjust the working mode to M
		Lighting installation area is a long time cloudy and rainy days (more than 5 days)	Under normal circumstances, sunny day after charging the solar panel to observe the lights at night
3	Lights fail to turn on properly when humans approach	Check the working mode is corret or not	adjust working mode to M or U
		Check if the air temperature close to human body temperature	when the air temperature us close to human temperature, motion detection may slow down. It will return to normal after the air temperature changes
		Check if the installation height is too high	It is out of motion sensor detection range when installation height exceeds 8m. It is recommend to reduce the height or use other operating modes
		Check if there is a long rainy and cloudy, when power is not enough, the light will turn to smart power mode compulsorily to ensure long time lighting, Even it is sensed, the light won't turn to brighter mode.	When sunshine is good, the light will turn to normal working mode again automatically and has sensor function.

Lighting mode can be customized before shipping

Mode M

Sensor Lighting Mode

01

30% when no
body



02

100% when
people come close



Mode L

Timing Lighting Mode

01

100% brightness
in first 2 hours



02

70% brightness
for 4 hours



03

20% brightness
for 6 hours

Remote Control Technology



Working modes can be chosen from:

ON : Turn on the light

OFF : Turn off the light

70% : Test at 70% brightness for 1 minute

50% : Test at 50% brightness for 1 minute

30% : Test at 30% brightness for 1 minute

+10% : Test brightness increased by 10% for one minute









- 10% : Test brightness reduced by 10% for one minute

Remark:

- * Sensing Control Mode: 100% brightness with people come close, 30% without people.
- * Timing Control Mode: 100% brightness -2hrs, 70% brightness-4hrs, 30% brightness-6hrs.

Packing List

When opening the package, please confirm that all parts are received as listed below:

Components	40W-120W	Images
Unit main body	1pc	
Big anchor ear	1pc	
Small anchor ear	1pc	
M8x60 screw	6sets	
Ø6mm Allen key	1pc	
Open spanner	1pc	
User Manual	1pc	
Remote control	1pc	

Installation

1. Connect the cable between solar panel and lamp

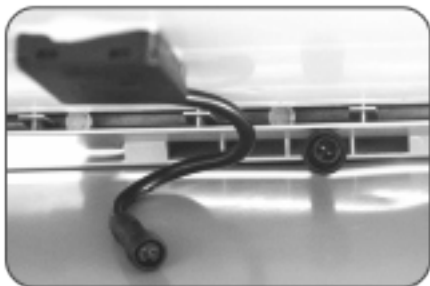

2. Fix solar street light on to the pole with 6 pcs screws.



Poles (suggest upper diameter of pole 70-76mm)

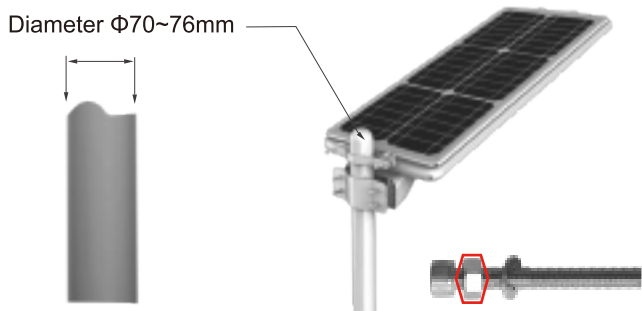

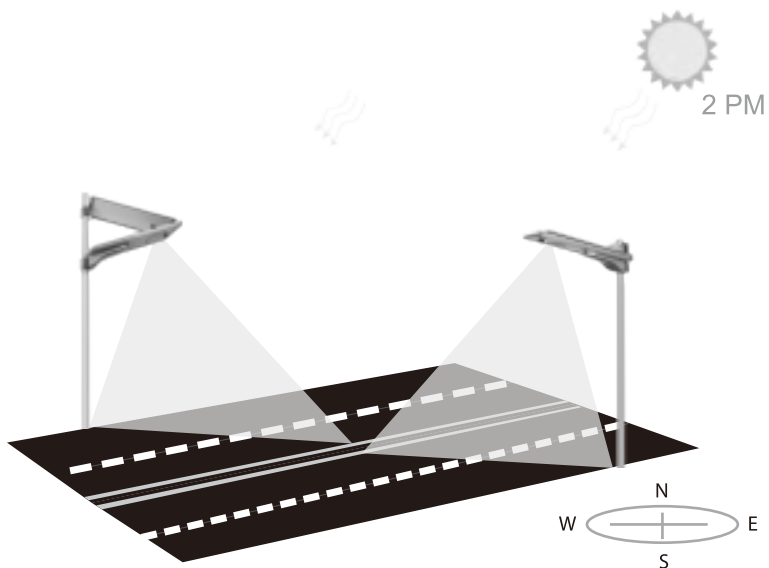

Installation Height and Distance

Install according to the height and distance (between the lamps) restrictions as set by each respective product type. Consult our product specialists for special lighting requirements.

Power	Height of pole	Distance between pole
40W	4~6m	15~20m
64W	6~8m	20~25m
100W	7~9m	25~30m
120W	8~12m	30~35m

How to turn on our solar street lights ?

Notice: Please do not need Press ON button of remote to turn on the lamp, because our PALM units have Automatic Activation Function.

Activation:

Palm tree solar street light will be automatically lighting at night without any manually operation. Palm tree solar street light will turn on at dusk and turn off at dawn automatically.

If you want to check whether the PALM Unit are lighting during the daytime:

1. Please cover the solar panels with shelters, it means at night, and then connect the cables, the lamp will be lighting.
2. If you take down the shelters, it means at daytime, the lamp will be off automatically.

Installation caution

1. Trees or building do not exceed lamp too high, in case of shadows on solar panel



2. Pole do not exceed lamp too long, in case of shadows on solar panel

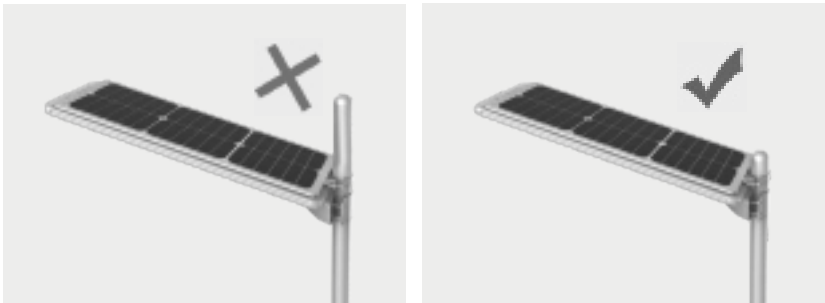

When need to fold or unfold?

In the northern hemisphere, the sun shines from the south
In the southern hemisphere, the sun shines from the north

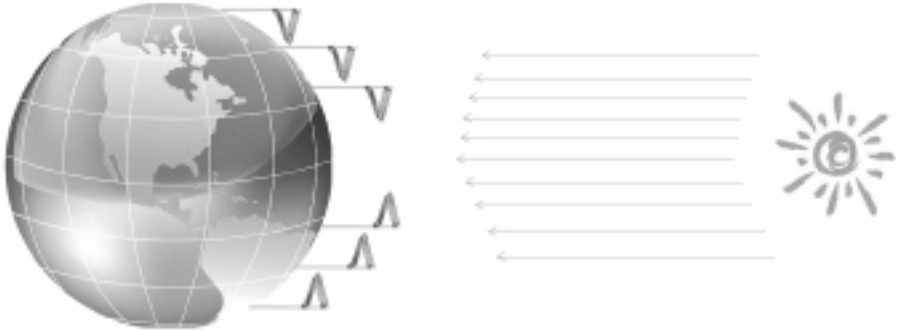

In order to ensure the solar panel face the sun, when will it fold or unfold?

In northern hemisphere, unfold in north side of road, fold in south side of road
In southern hemisphere, fold in north side of road, unfold in south side of road

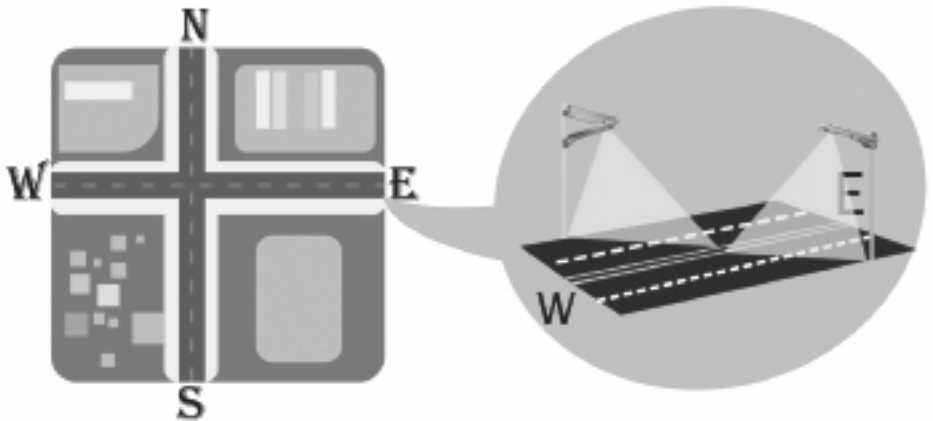

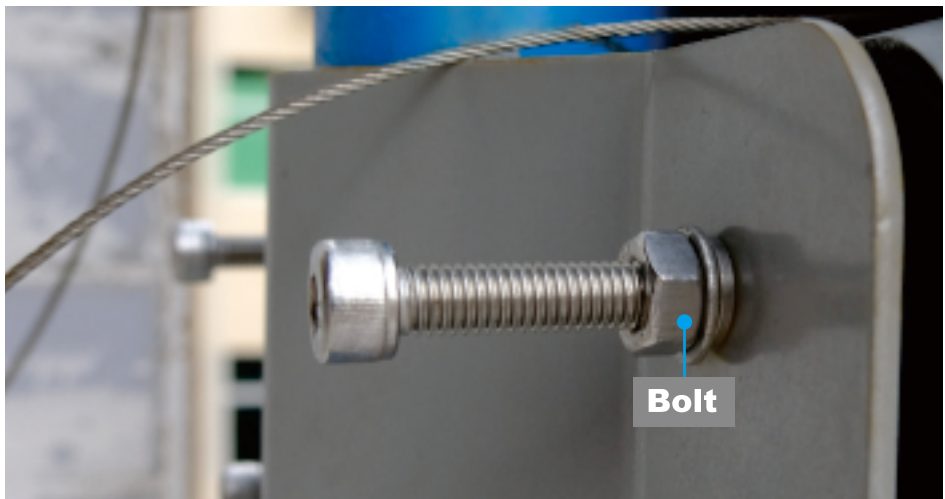

If any question, you can ask us or watch installation Video from our website.